

10円コロコロゲーム貯金箱作り方のコツ

【取扱説明書】

サクラ 10円コロコロゲーム貯金箱
えん
つく かたせつめいしよ
 作り方説明書

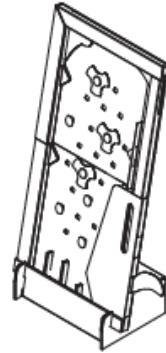
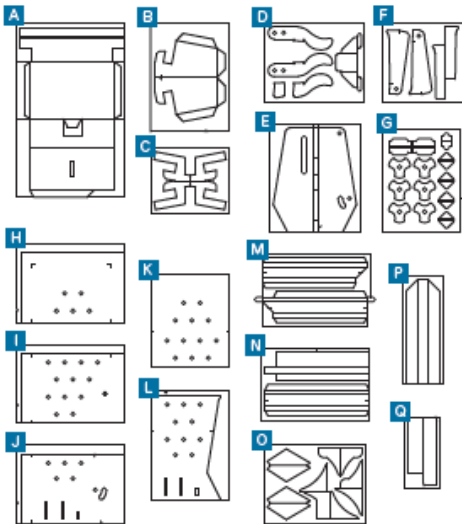

ポイント

- 作る前に図のように並べて入り組みを確認しよう。

- 接着にはボンドタッチ (多用塗接着剤または紙用接着剤) をつかってください。
- 紙製 (厚紙) です。大切に扱ってください。(折れたり壊れたりするおそれがあります。)
- のり付けする前には位置を確認してからはってください。
- サクラホームページには作り方説明書があります。



 輪ゴムを3本準備しよう



(透明シート1枚)

ご注意 保護者の方へ、必ずお読みください。

- 小さな部品が入っています。口の中には絶対に入れないでください。窒息などの危険があります。また、買った部品が入っていますので十分注意してお取り扱ってください。
- 幼児が使用する場合は保護者のもとで使用させてください。
- 輪ゴムの取り付けはまわりに気を付けて、必ず保護者の方と一緒にしてください。

【出来上がりイメージ】



貯金箱部分を作ろう①

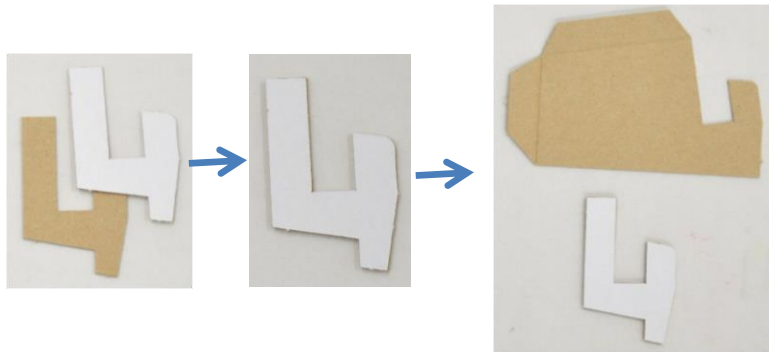
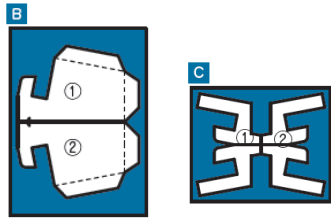

【完成品①】



× 2コ
(1つ逆向き)

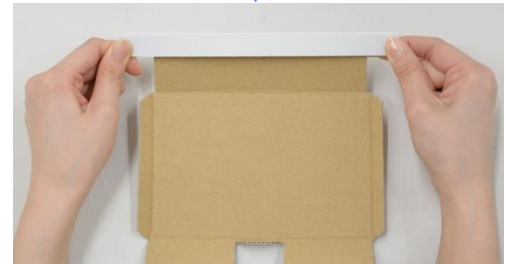
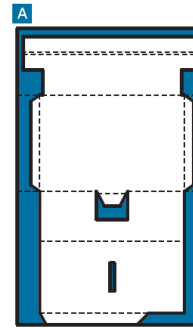

【完成品②】



接着剤(ボンドタッチ)を塗り、図のように貼り付けます。

貯金箱部分を作ろう②

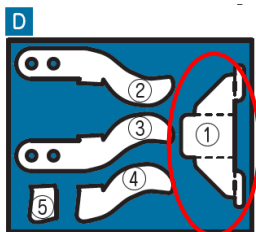

【完成品①】



× 2コ

【完成品②】

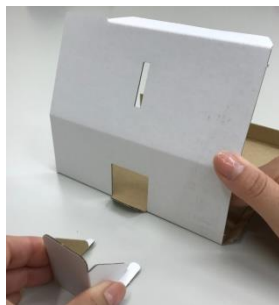
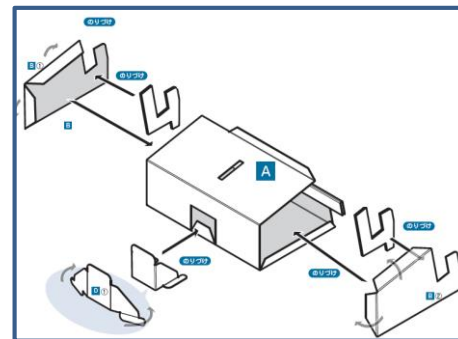

反対側も同じ用に

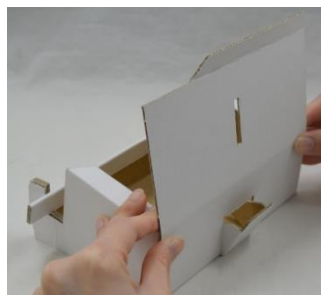
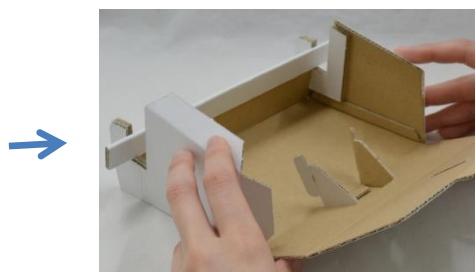
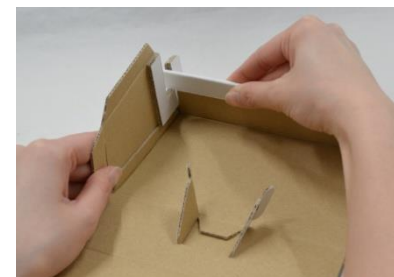

【完成品③】



接着剤(ボンドタッチ)を塗り、図の順番で①・完成品①・完成品②を貼り付けます。

レバーを作ろう

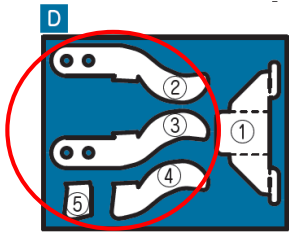

セロハンテープ

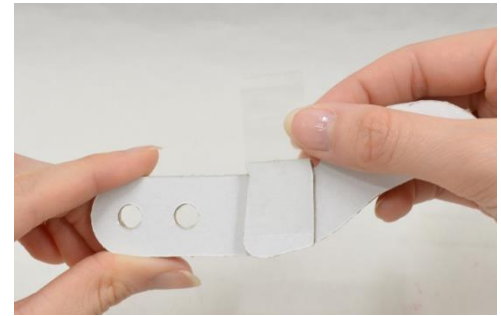
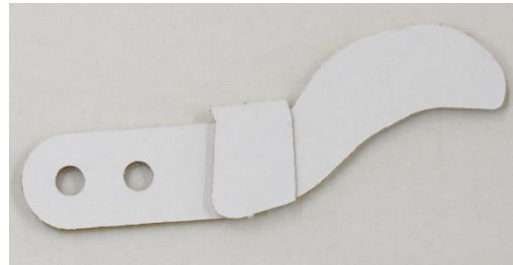

接着剤(ボンドタッチ)を塗り、②～⑤を貼り付け、セロハンテープを4回重ねて貼ります。

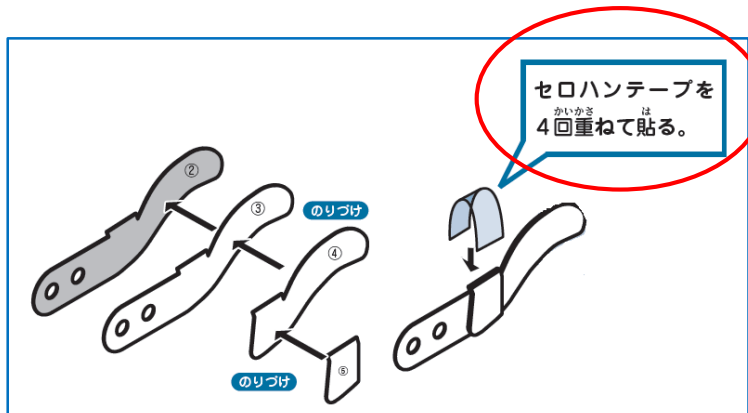

【完成品④】



盤面を作ろう①

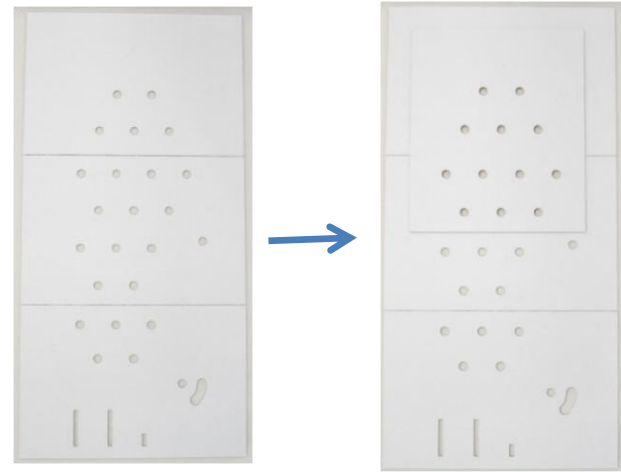
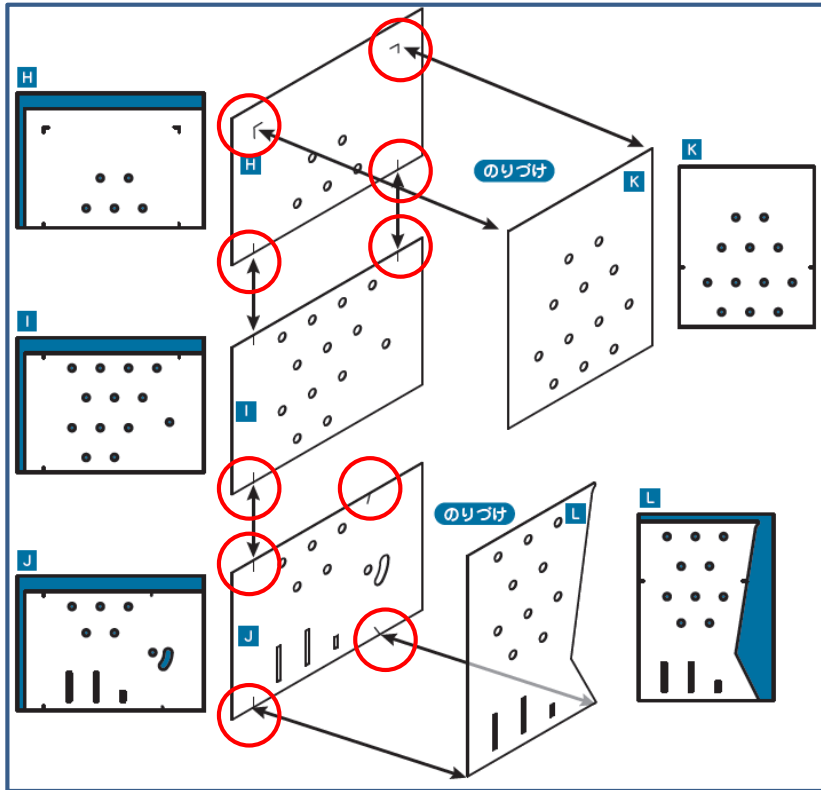
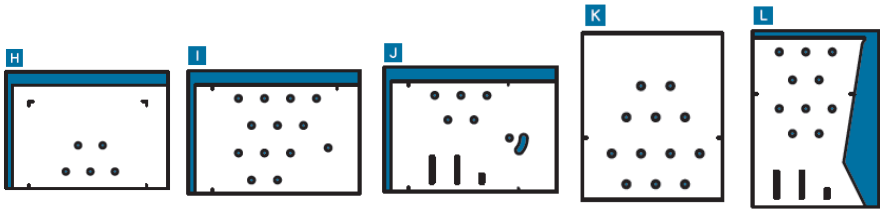

【完成品⑤】



図のように接着剤(ボンドタッチ)で
貼り付けます。
アタリ線に合わせて貼ると、簡単！

盤面を作ろう②

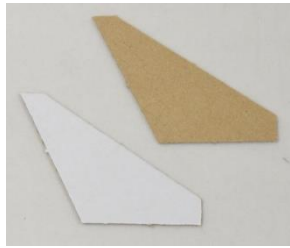
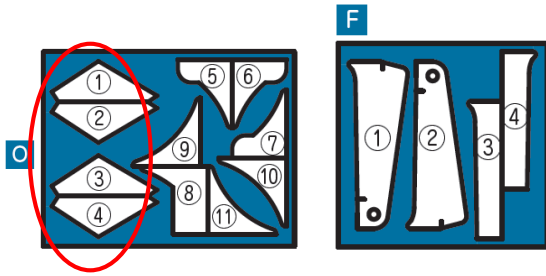

× 2コ

【完成品⑥】

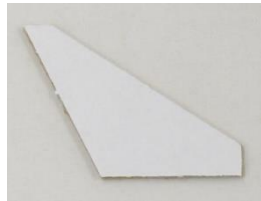

この部品が2つ
できるため、2つを
さらに貼り付けます。



【完成品⑦】



【完成品⑧】



図のように接着剤(ボンドタッチ)で貼り付けます。

盤面を作ろう③

【完成品⑤】



【完成品⑦】 【完成品⑧】

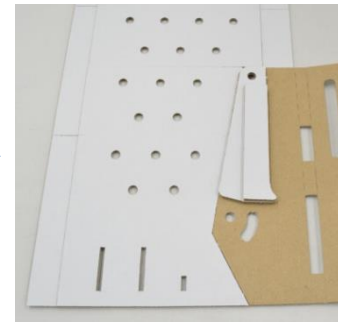
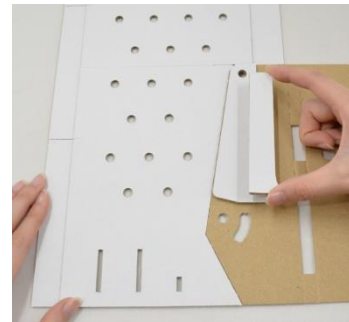
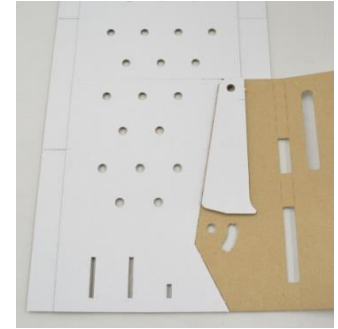
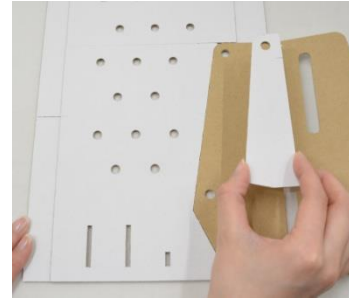
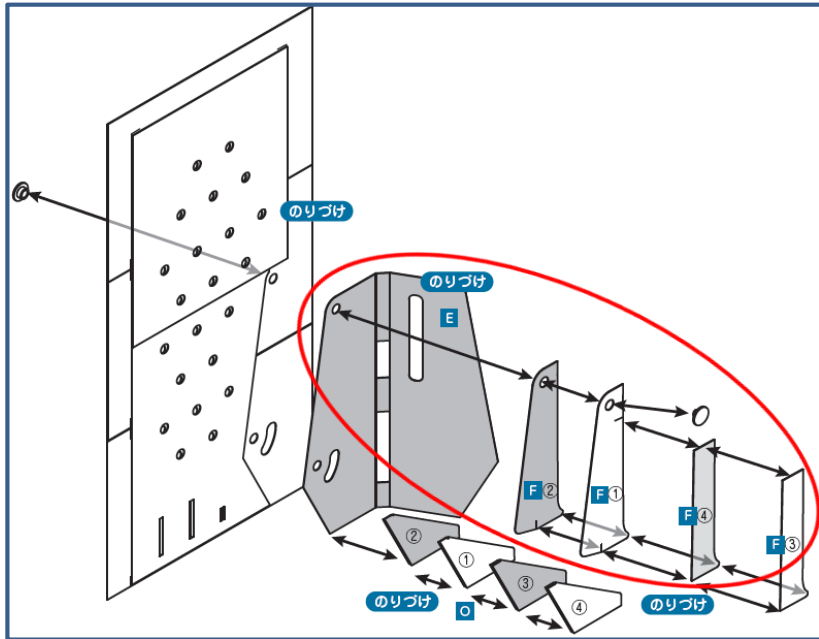

図のように完成品⑦・⑧を接着剤(ボンドタッチ)で貼り付けます。

盤面を作ろう④

【完成品⑤】



【完成品⑥】



プラネジ1組

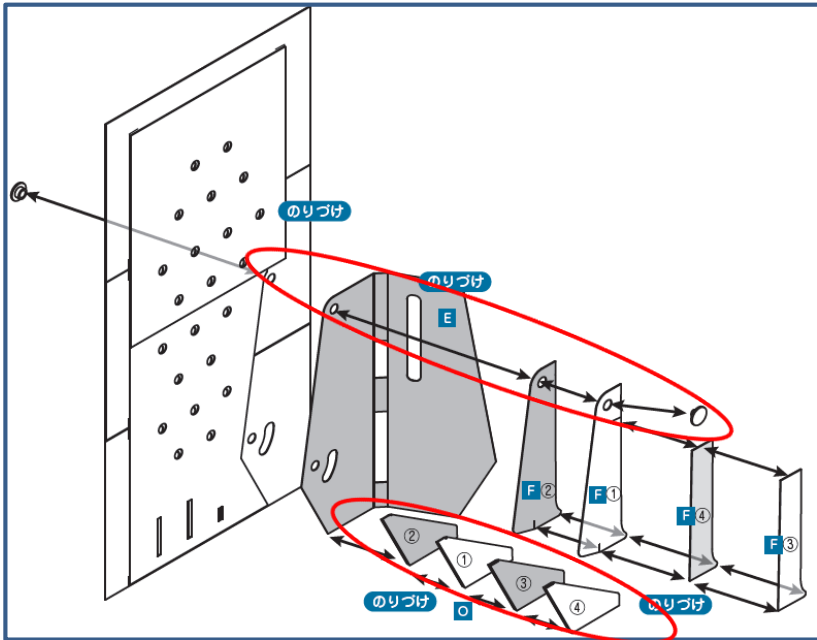
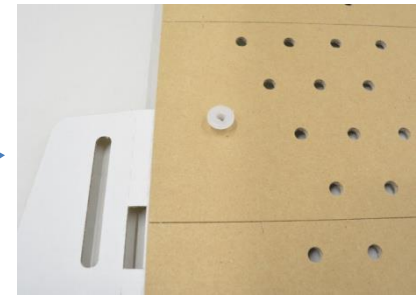
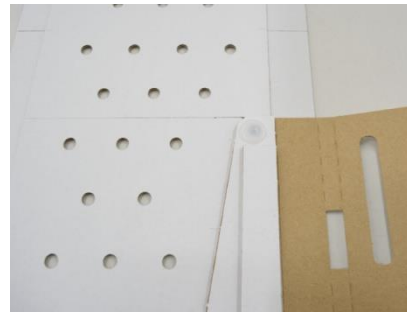
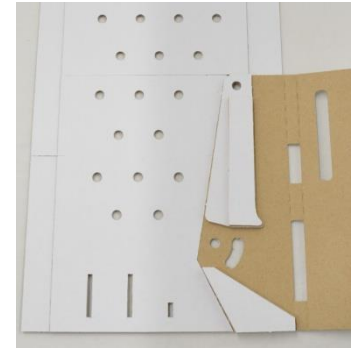
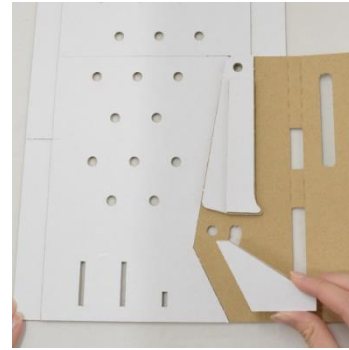

【完成品⑨】

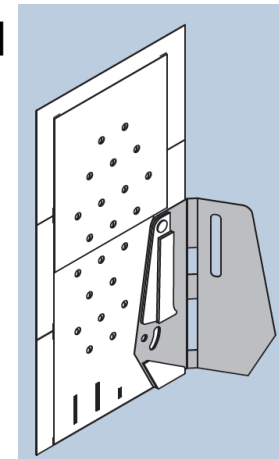

図のように完成品⑥を
接着剤(ボンドタッチ)で貼り付け、
プラネジをつけます。

盤面とレバーをくっつけよう①

【完成品⑨】

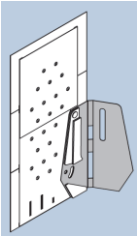

【完成品④】



プラネジ2組

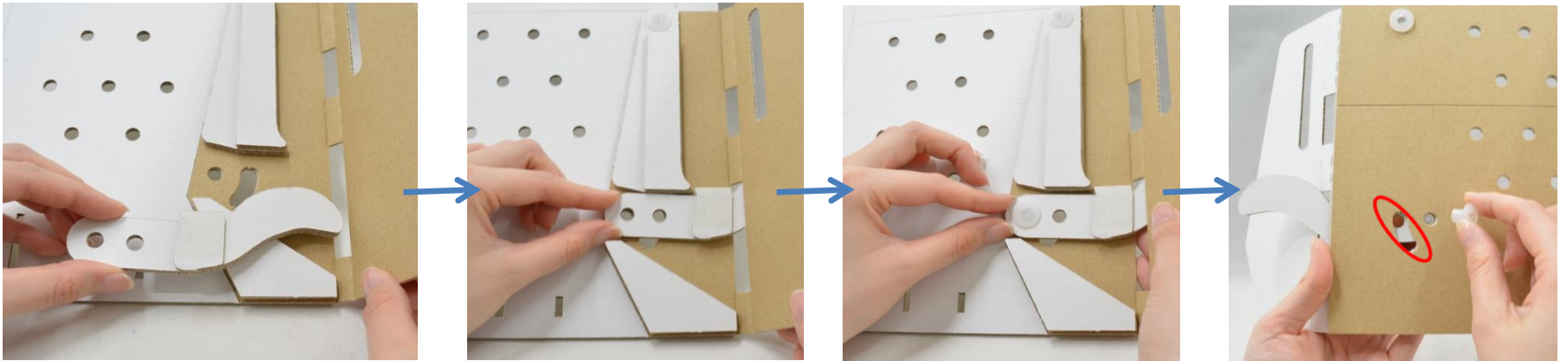
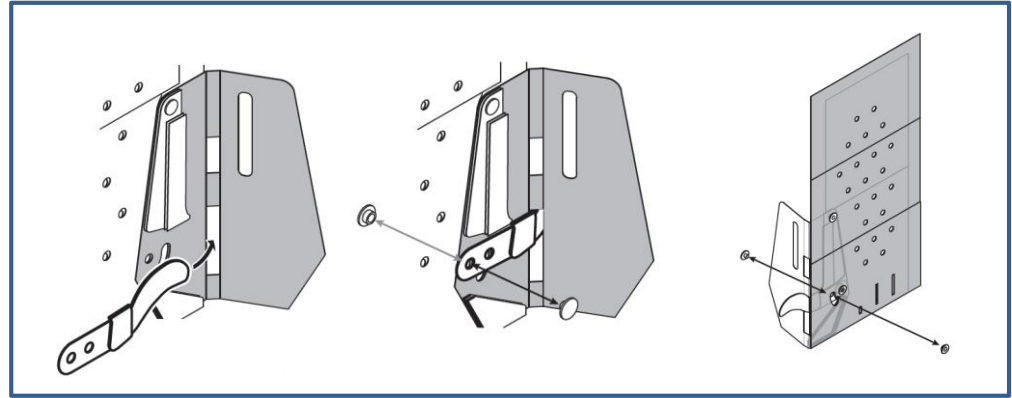

図のように完成品⑨に完成品④をプラネジを付けます。(プラネジ2組)
赤囲みの方のネジはあとで輪ゴムをひっかけるため、少しゆるめにつけ、
後ほど輪ゴムをつけてからしっかりとめます。

盤面とレバーをくっつけよう②

輪ゴム



3本の輪ゴムを一度ねじり、2重にして取り付けます。

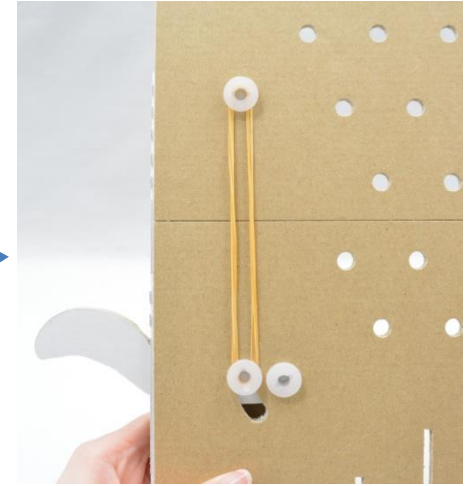
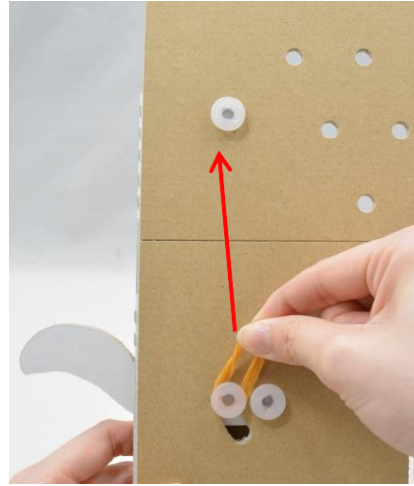
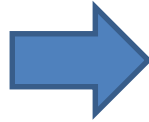
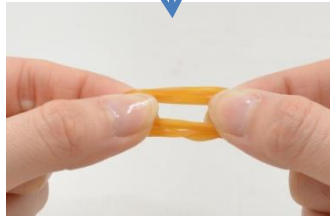
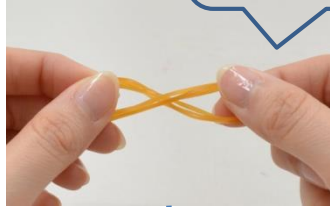

前のスライド(スライド9)で組み立てた盤面に、図のように輪ゴムを取り付けます。
輪ゴムの取り付けはまわりに気を付けて、必ず保護者の方と一緒に行ってください。

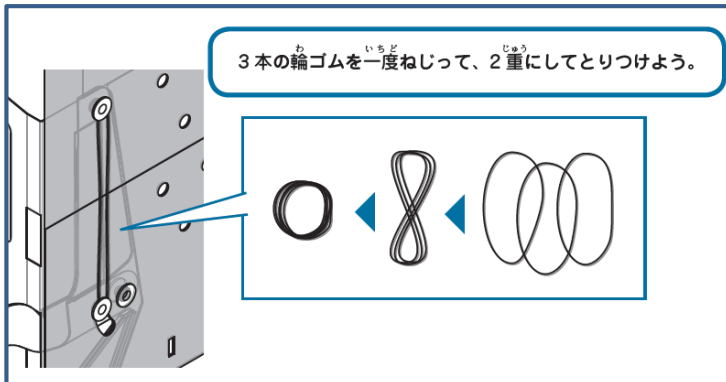

【完成品⑩】

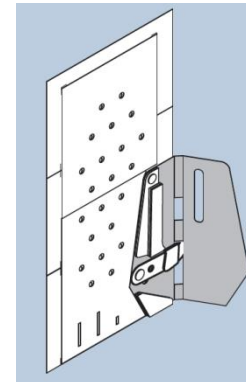

フレームをつけよう①

【完成品⑩】

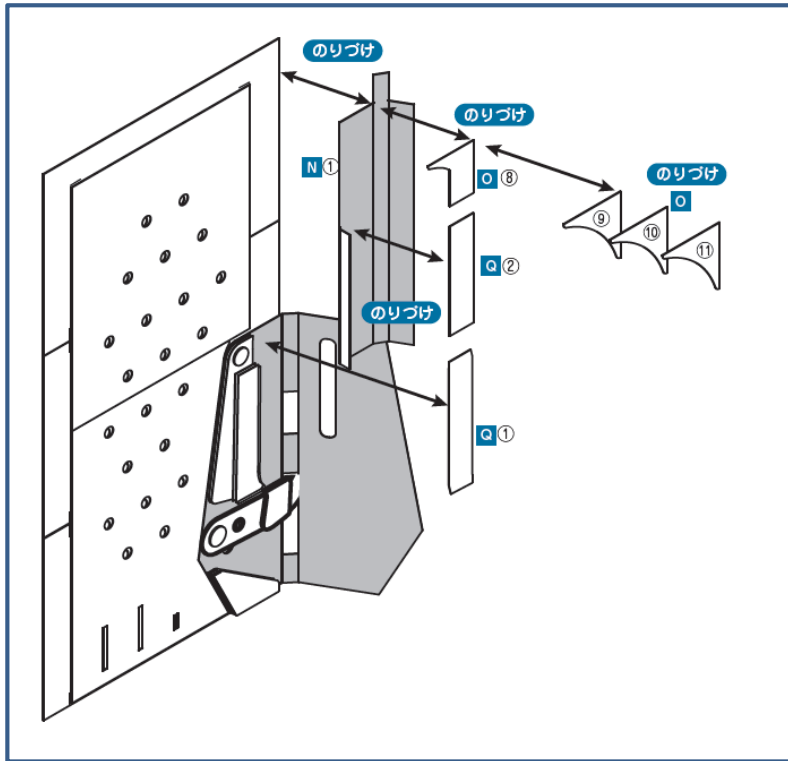
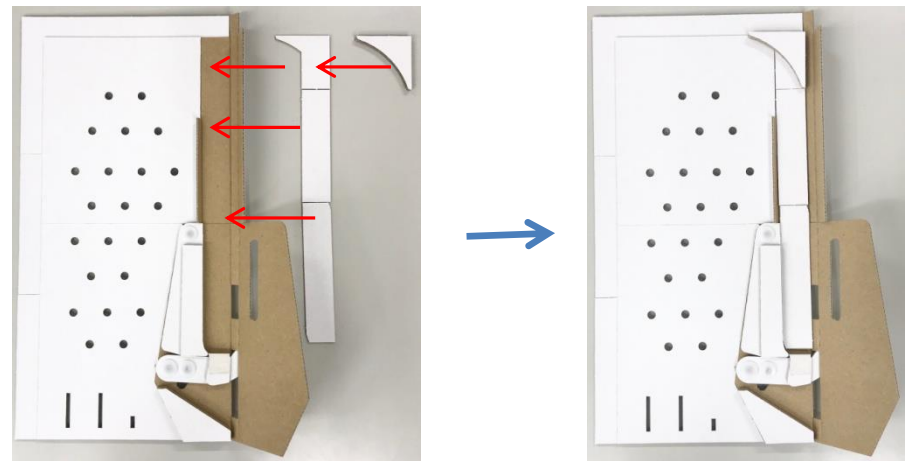
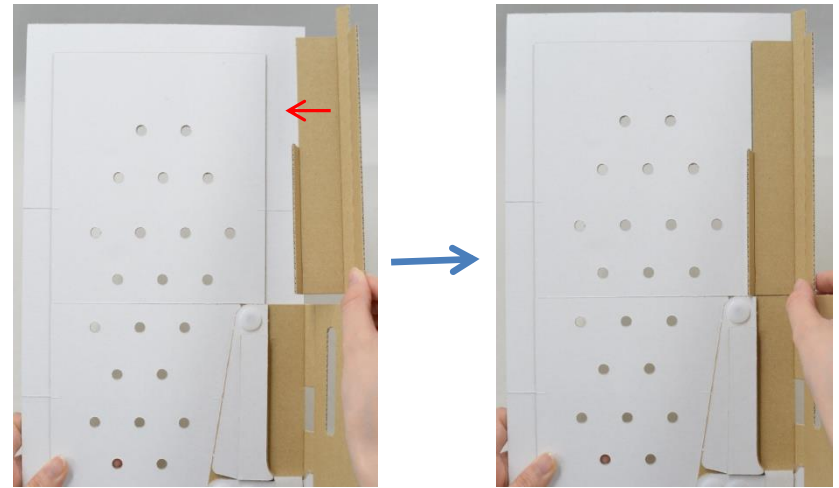
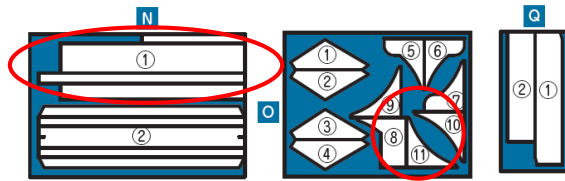
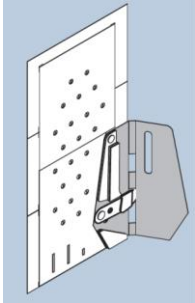

図のように、完成品⑩に必要なパーツを接着剤(ボンドタッチ)で貼り付けます。

フレームをつけよう②

【完成品⑩】

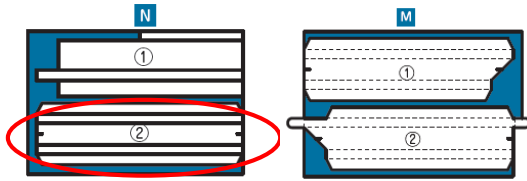
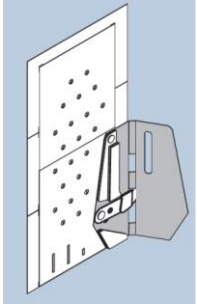

【完成品⑪】

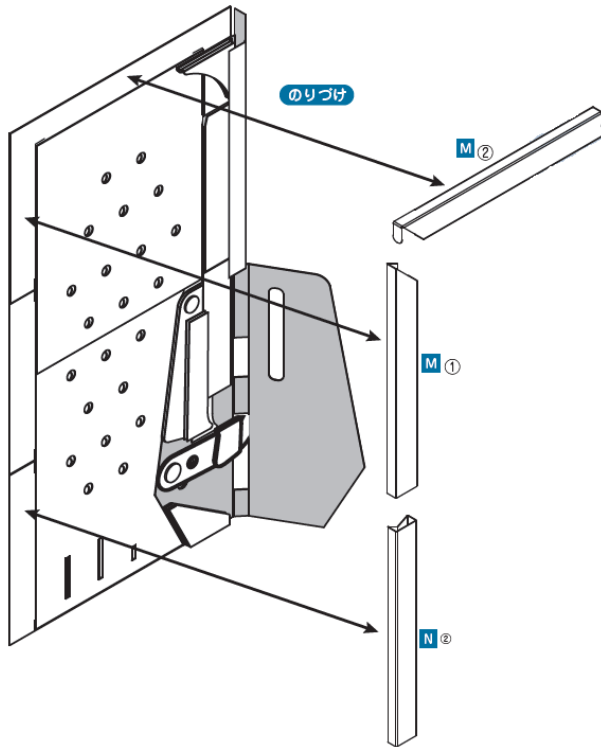
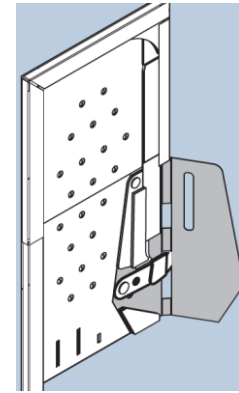

色をつける場合は、盤面はこの段階で色付けしましょう。

図のように、完成品⑩にN・Mを折り曲げて接着剤(ボンドタッチ)で貼り付けます。

盤面を仕上げていこう①

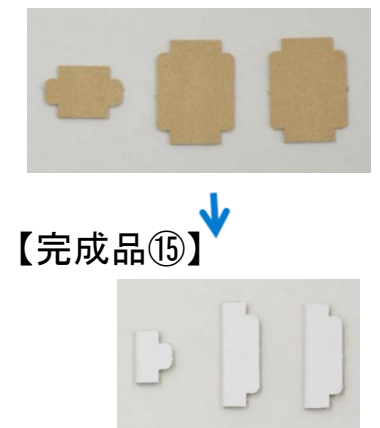
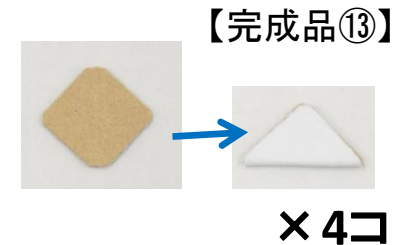
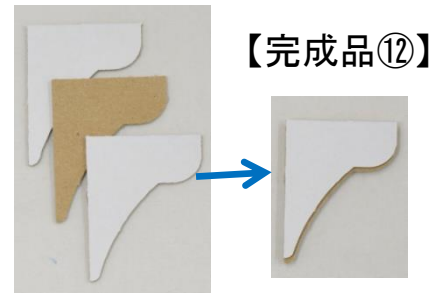
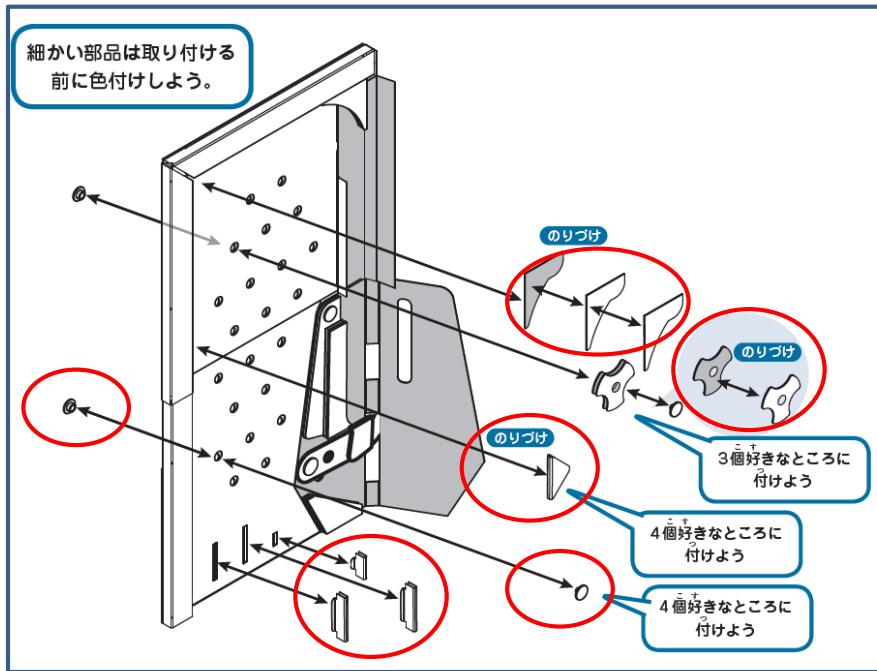
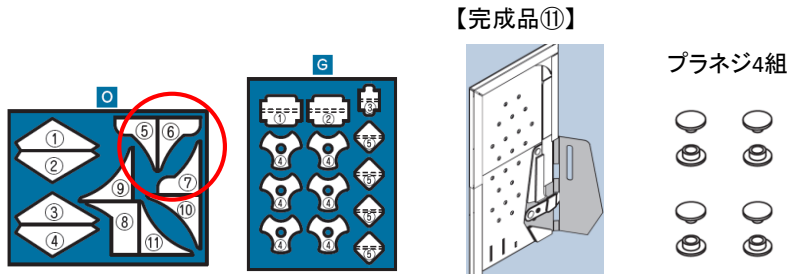

図のように、各パーツを接着剤(ボンドタッチ)で貼り付け、好きなのところにプラネジを取り付けます。

盤面を仕上げていこう②

【完成品⑫】



【完成品⑬】



【完成品⑭】



【完成品⑮】



プラネジ3組

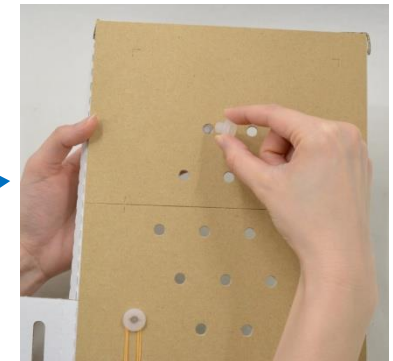
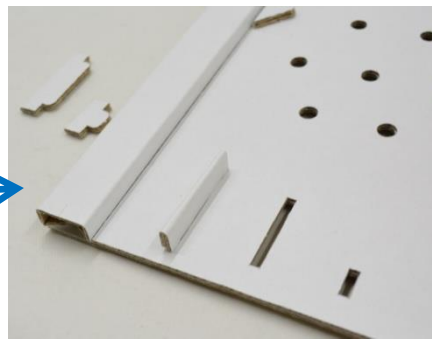
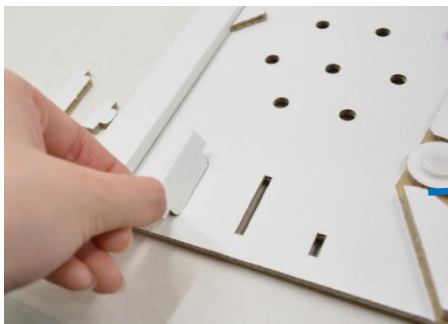
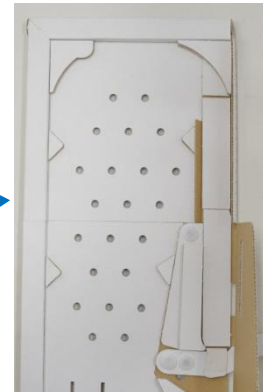

×3コ

図のように、完成品⑫～⑮をボンドタッチとプラネジで取り付けます。

盤面を仕上げていこう③

【完成品⑩】

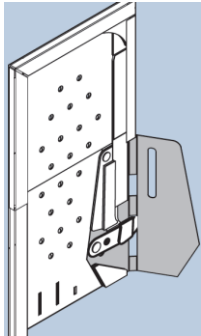

透明シート

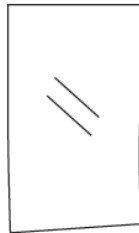

【完成品③】



セロハンテープ



コインを入れ、
レバーを引いて、
コインがきちんと動くか
確認しよう！

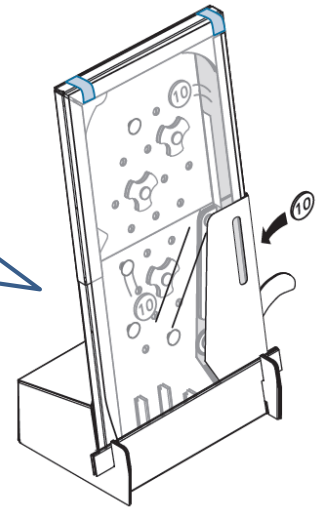

透明シートはアタリ線に
合わせて貼ろう！

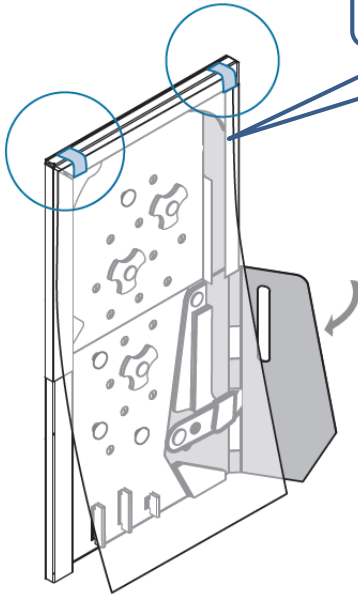

【完成品⑩】



図のように、透明シートをセロハンテープ仮り止めし、完成品③に
仮り置きでセットします。

※この時点では接着剤はつけずに、まずコインがきちんと動くか確認！

フレームを完成させよう

【完成品⑩】

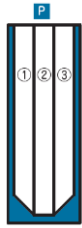

【完成品③】

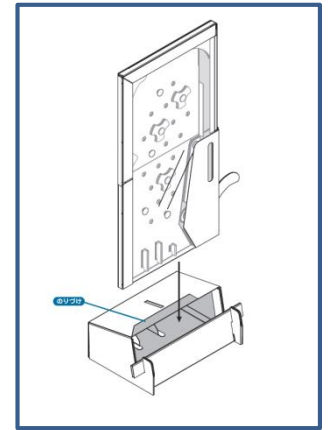
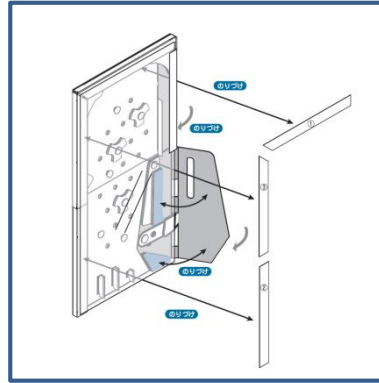

レバーカバー部分は接着剤を塗る場所に注意！
(赤囲み部分のみ)

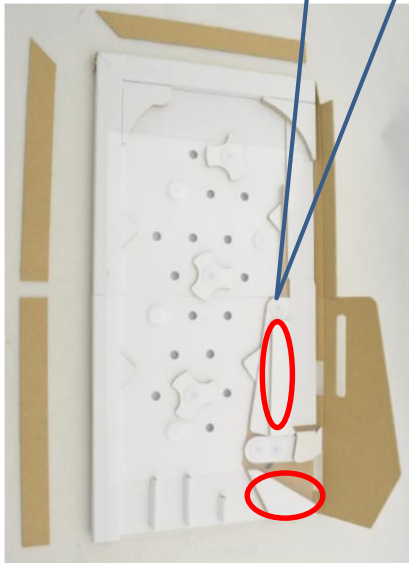

【完成！】



図のように、フレームを接着剤(ボンドタッチ)で貼り付け、レバーカバー部分も貼ります。**完成品③の貯金箱部分にセットして完成！**